

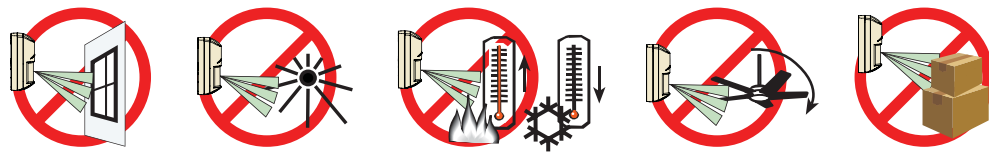

Installation Guide

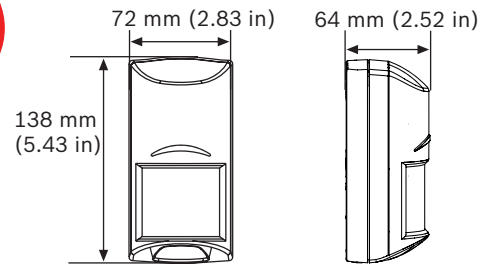

Pet Friendly
1 dog ≤ 45 kg (100 lbs)
2 dogs ≤ 27 kg (60 lbs)
or up to 10 cats
Not tested by UL

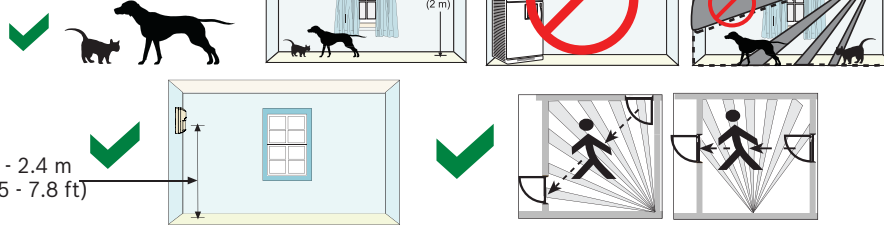

UL - only model RFDL-11-A is evaluated by UL

UL639: Standard for Intrusion-Detection Units
(Pet Friendly Immunity is not a feature of UL639)

FCC, Part 15



P/N: F.01U.261.834 - B810
P/N: F.01U.261.835 - RFRC-OPT

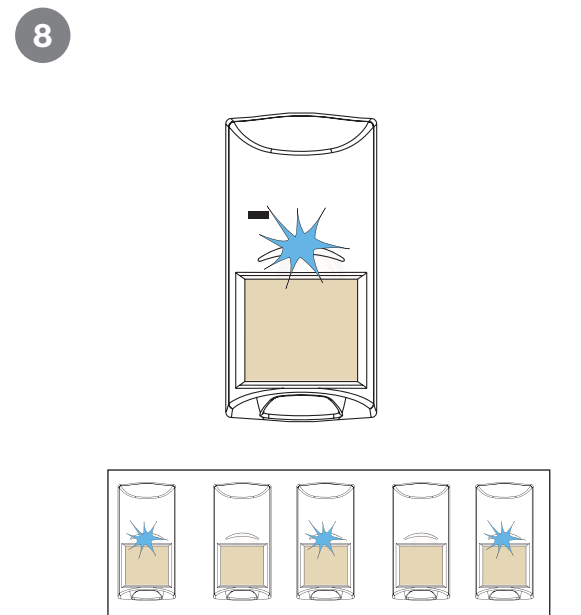
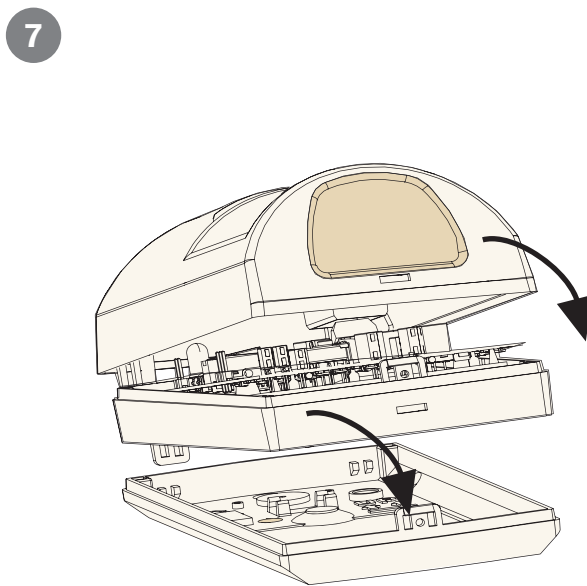
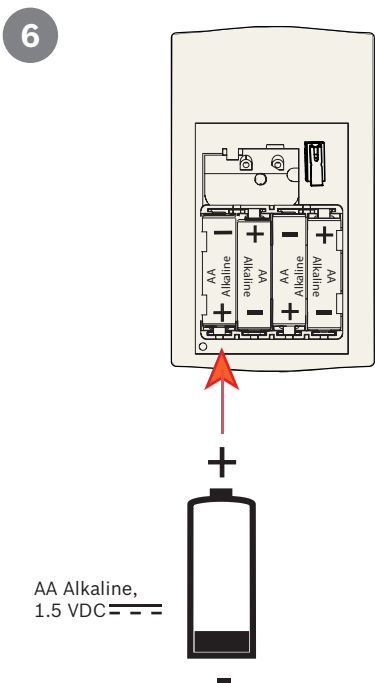
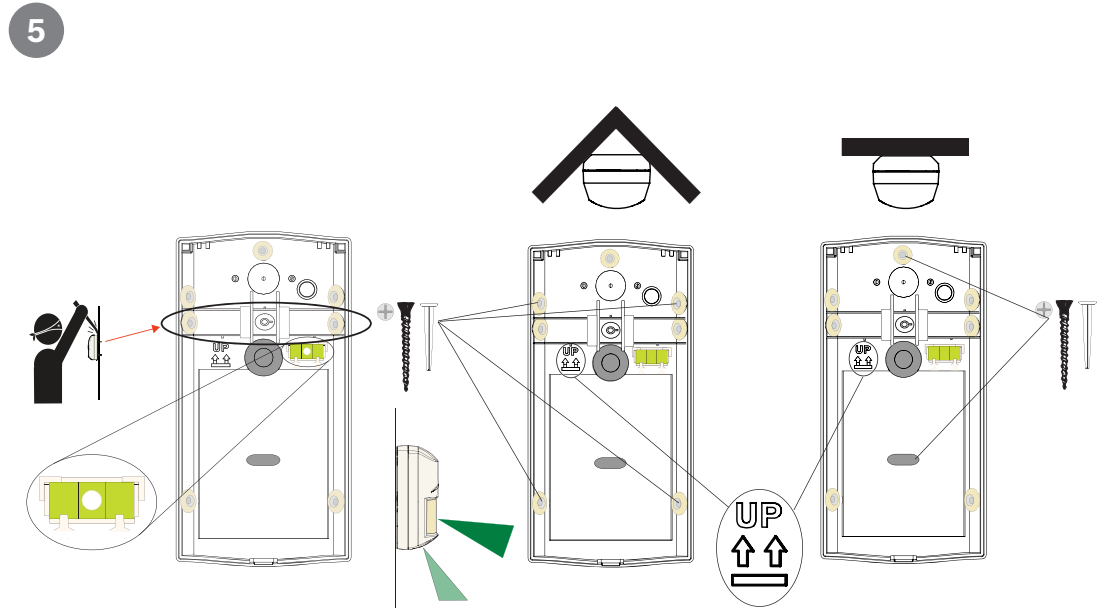
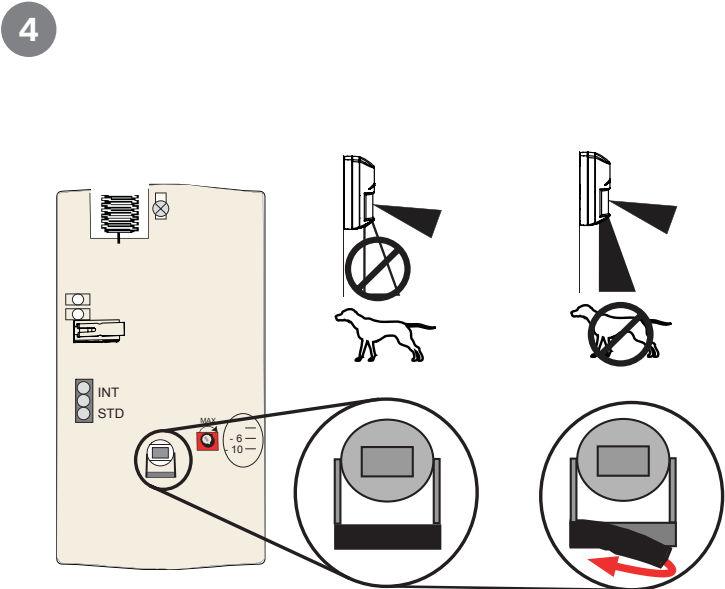
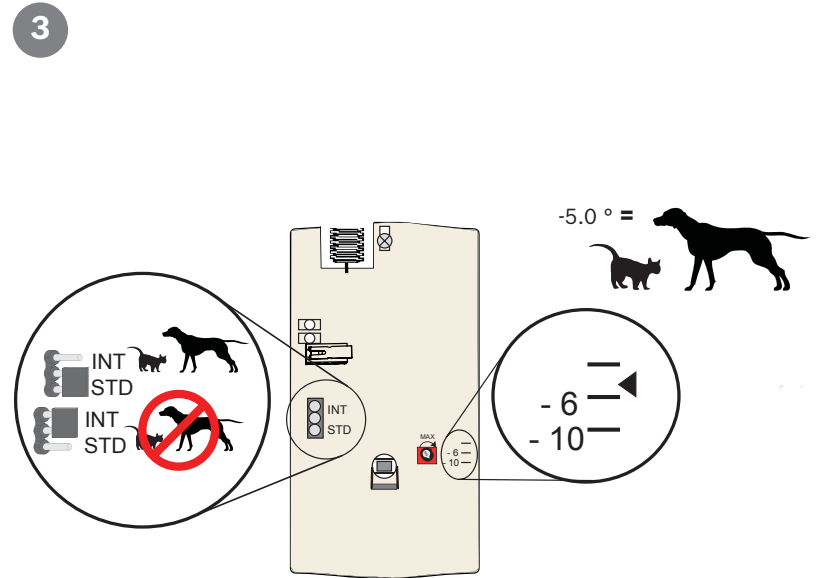
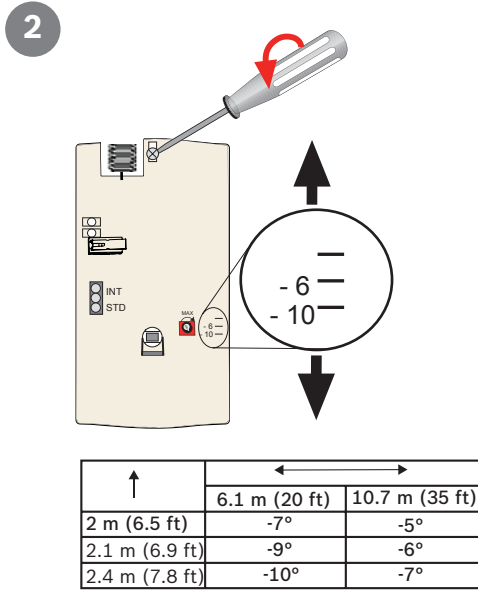
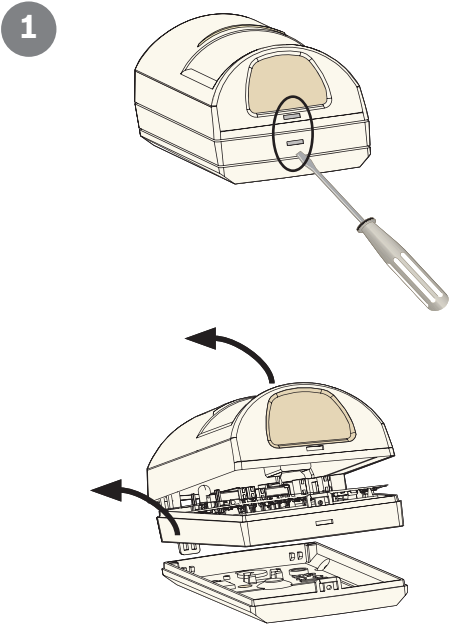
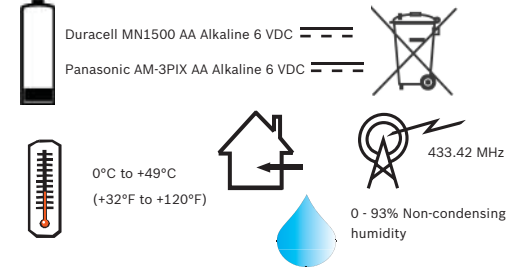

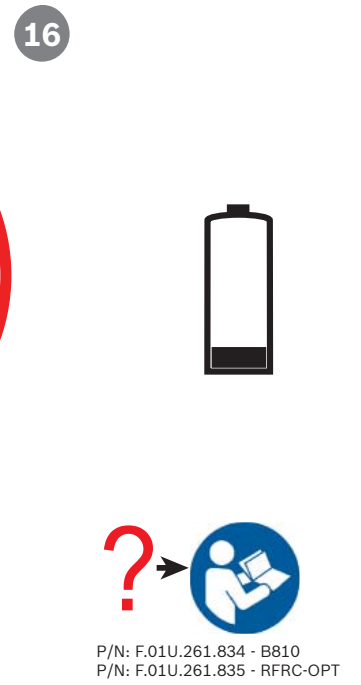
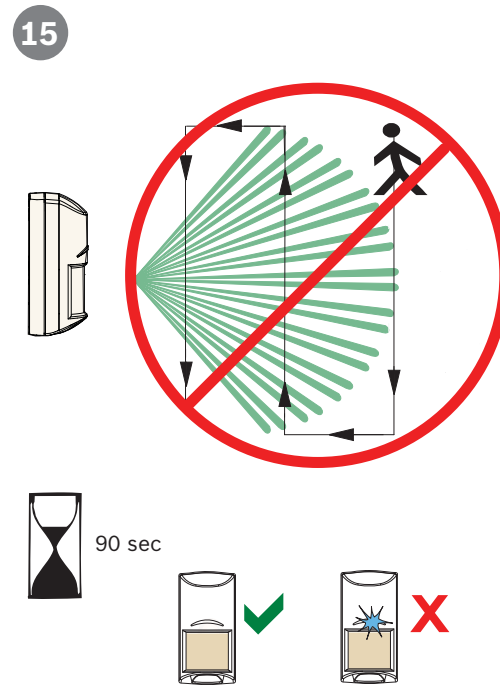
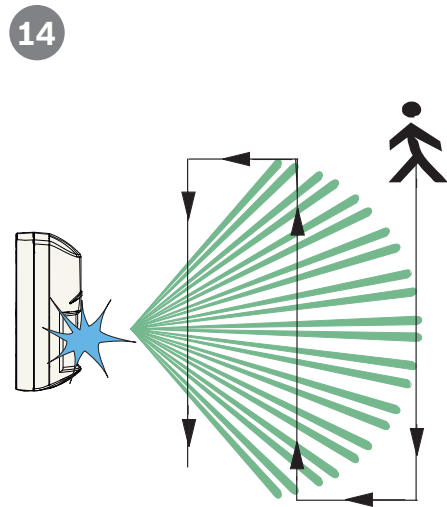
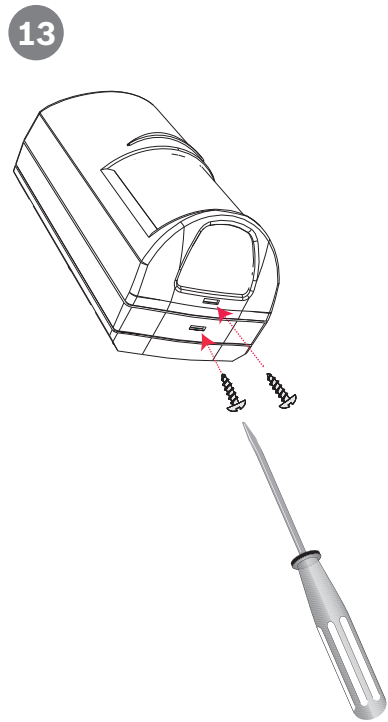
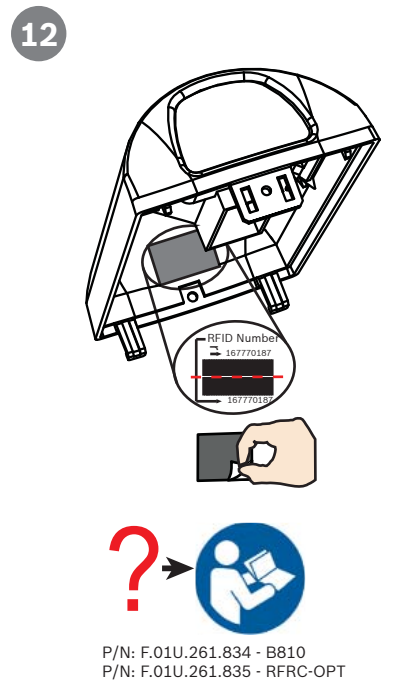
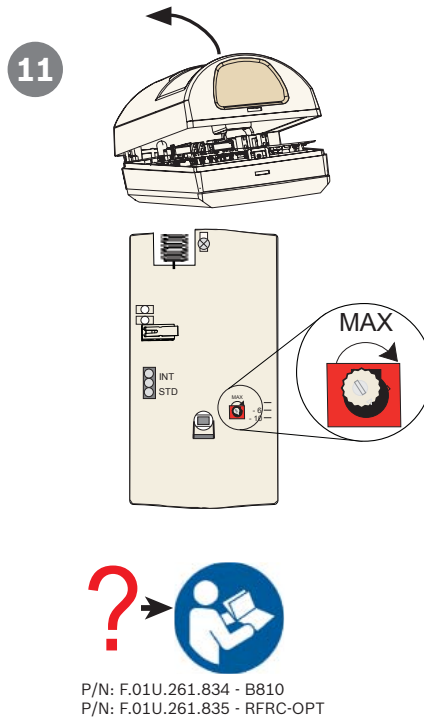
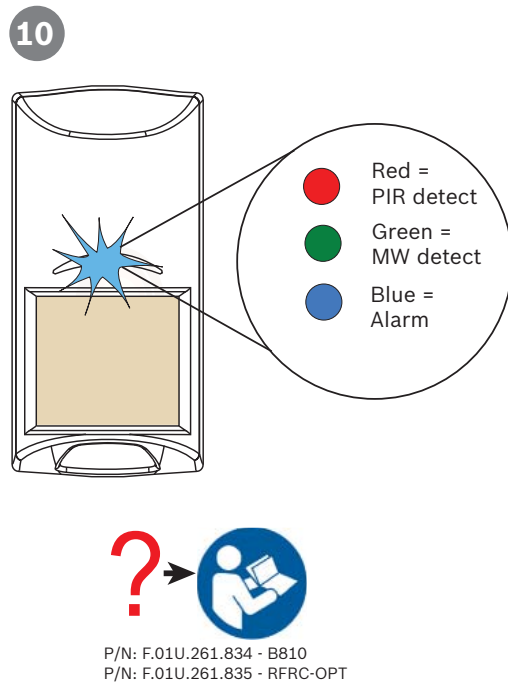
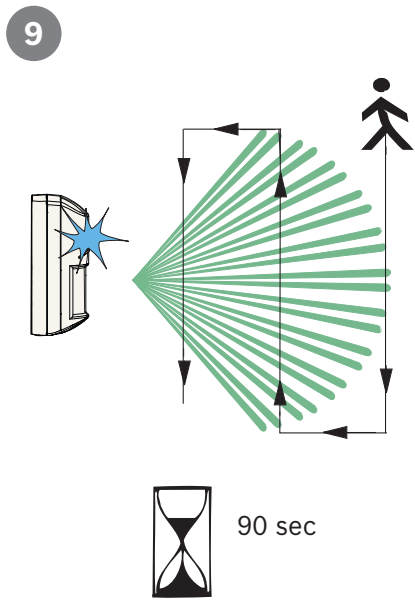

English

Hereby, Bosch Security Systems, declares that this intrusion detector is in compliance with the essential requirements and other relevant provisions of Directive 1999/5/EC.

Finnish

Bosch Security Systems vakuuttaa täten että rikosilmoitin tyyppinen laite on direktiivin 1999/5/EY oleellisten vaatimusten ja sitä koskevien direktiivin muiden ehtojen mukainen.

Dutch

Hierbij verklaart Bosch Security Systems dat het toestel inbraakdetector in overeenstemming is met de essentiële eisen en de andere relevante bepalingen van richtlijn 1999/5/EG. Bij deze verklaart Bosch Security Systems dat deze inbraakdetector voldoet aan de essentiële eisen en aan de overige relevante bepalingen van Richtlijn 1999/5/EC.

French

Par la présente Bosch Security Systems déclare que l'appareil détecteur d'intrusion est conforme aux exigences essentielles et aux autres dispositions pertinentes de la directive 1999/5/CE. Par la présente, Bosch Security Systems déclare que ce détecteur d'intrusion est conforme aux exigences essentielles et aux autres dispositions de la directive 1999/5/CE qui lui sont applicables.

Swedish

Härmed intygar Bosch Säkerhetssystem att denna inbrottsdetektor står i överensstämmelse med de väsentliga egenskapskrav och övriga relevanta bestämmelser som framgår av direktiv 1999/5/EG.

Danish

Undertegnede Bosch sikkerhedssystemer erklærer herved, at følgende udstyr Indbrudsdetektor o verholder de væsentlige krav og øvrige relevante krav i direktiv 1999/5/EF.

German

Hiermit erklärt Bosch Sicherheitssysteme, dass sich dieser/diese/dieses Einbruchmelder in Übereinstimmung mit den grundlegenden Anforderungen und den anderen relevanten Vorschriften der Richtlinie 1999/5/EG befindet". (BMW). Hiermit erklärt Bosch Sicherheitssysteme die Übereinstimmung des Gerätes Einbruchmelder mit den grundlegenden Anforderungen und den anderen relevanten Festlegungen der Richtlinie 1999/5/EG. (Wien).

Greek

ΜΕ ΤΗΝ ΠΑΡΟΥΣΑ Σύστημα ασφαλείας Bosch ΔΗΛΩΝΕΙ ΟΤΙ Ανιχνευτής εισβολής ΣΥΜΜΟΡΦΩΝΕΤΑΙ ΠΡΟΣ ΤΙΣ ΟΥΣΙΩΔΕΙΣ ΑΠΑΙΤΗΣΕΙΣ ΚΑΙ ΤΙΣ ΛΟΙΠΕΣ ΣΧΕΤΙΚΕΣ ΔΙΑΤΑΞΕΙΣ ΤΗΣ ΟΔΗΓΙΑΣ 1999/5/ΕΚ.

Italian

Con la presente Bosch Security Systems dichiara che questo rilevatore antintrusione è conforme ai requisiti essenziali ed alle altre disposizioni pertinenti stabilite dalla direttiva 1999/5/CE.

Spanish

Por medio de la presente Bosch Security Systems declara que el detector de intrusión cumple con los requisitos esenciales y cualesquiera otras disposiciones aplicables o exigibles de la Directiva 1999/5/CE.

Portuguese

Bosch Security Systems declara que este detector de intrusão está conforme com os requisitos essenciais e outras disposições da Directiva 1999/5/CE.

Copyright

This document is the intellectual property of Bosch Security Systems, Inc. and is protected by copyright. All rights reserved.

Trademarks

All hardware and software product names used in this document are likely to be registered trademarks and must be treated accordingly.

Bosch Security Systems, Inc. product manufacturing dates

Use the serial number located on the product label and refer to the Bosch Security Systems, Inc web site at: <http://www.boschsecurity.com/datecodes/>.

Top View

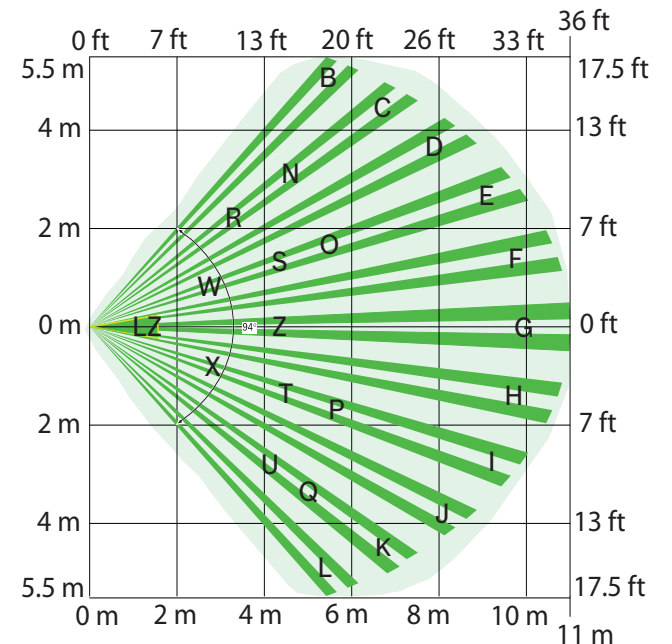

Side View

